

Fig. 1

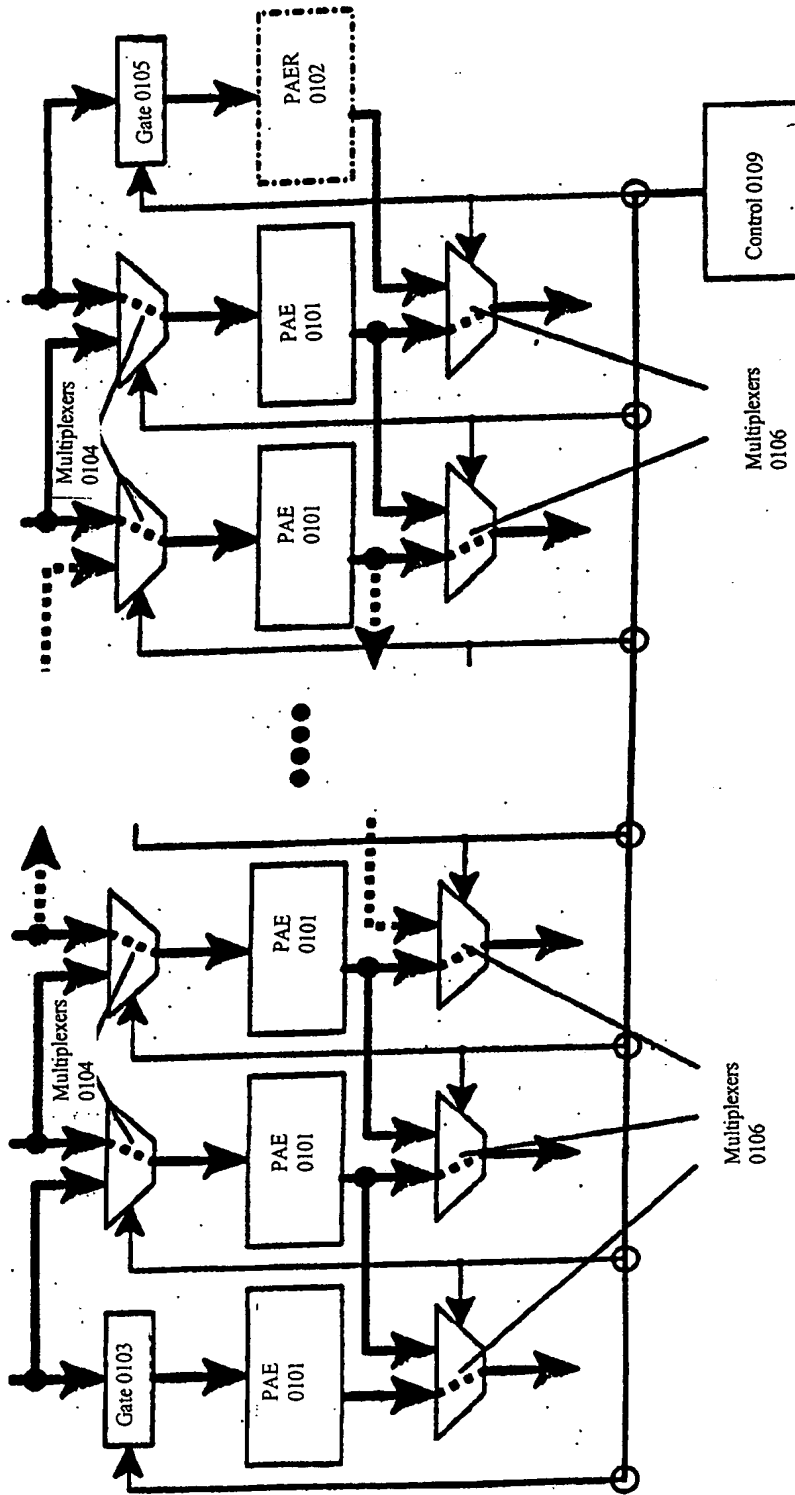

Fig. 2

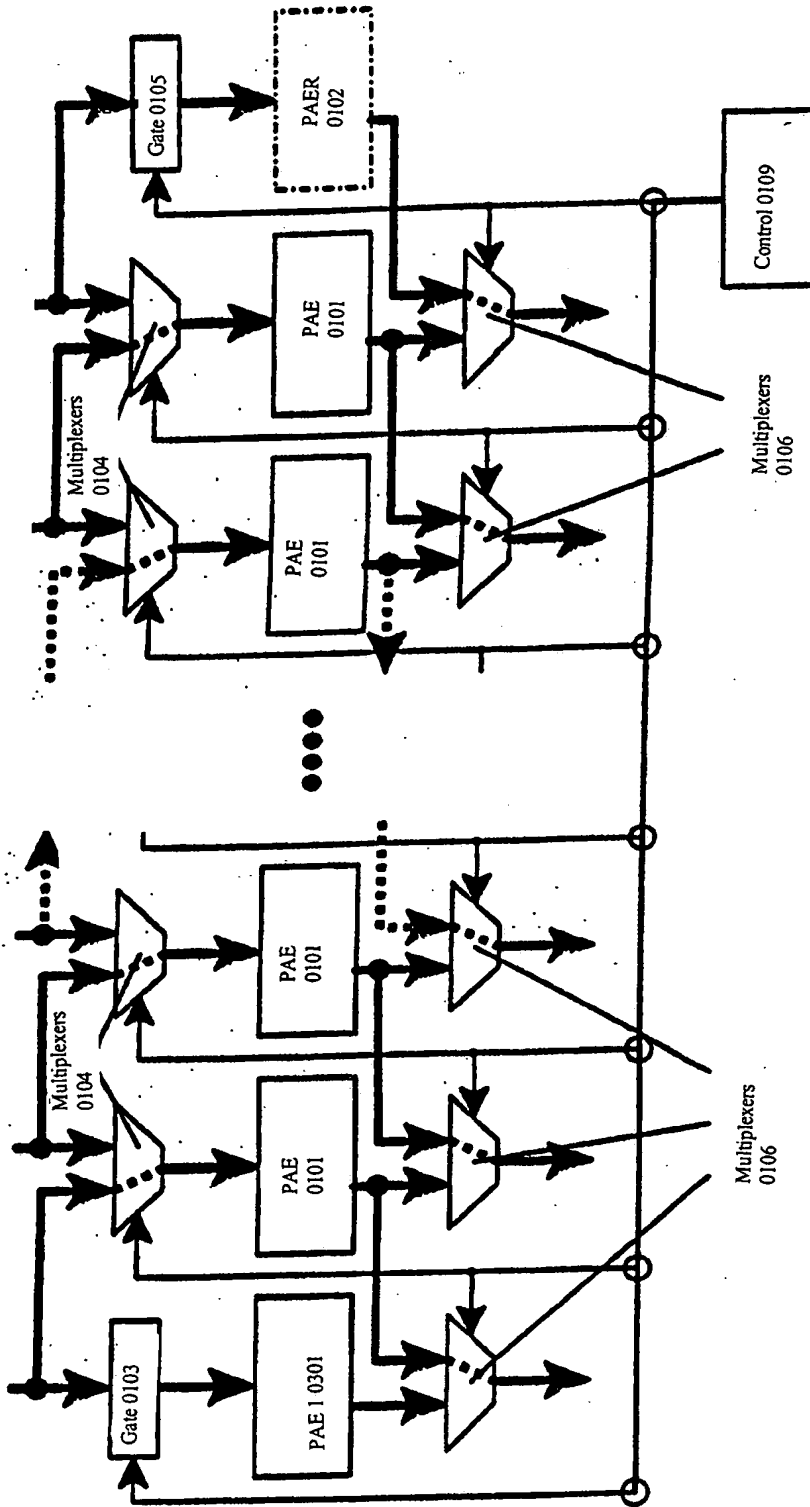

Fig. 3

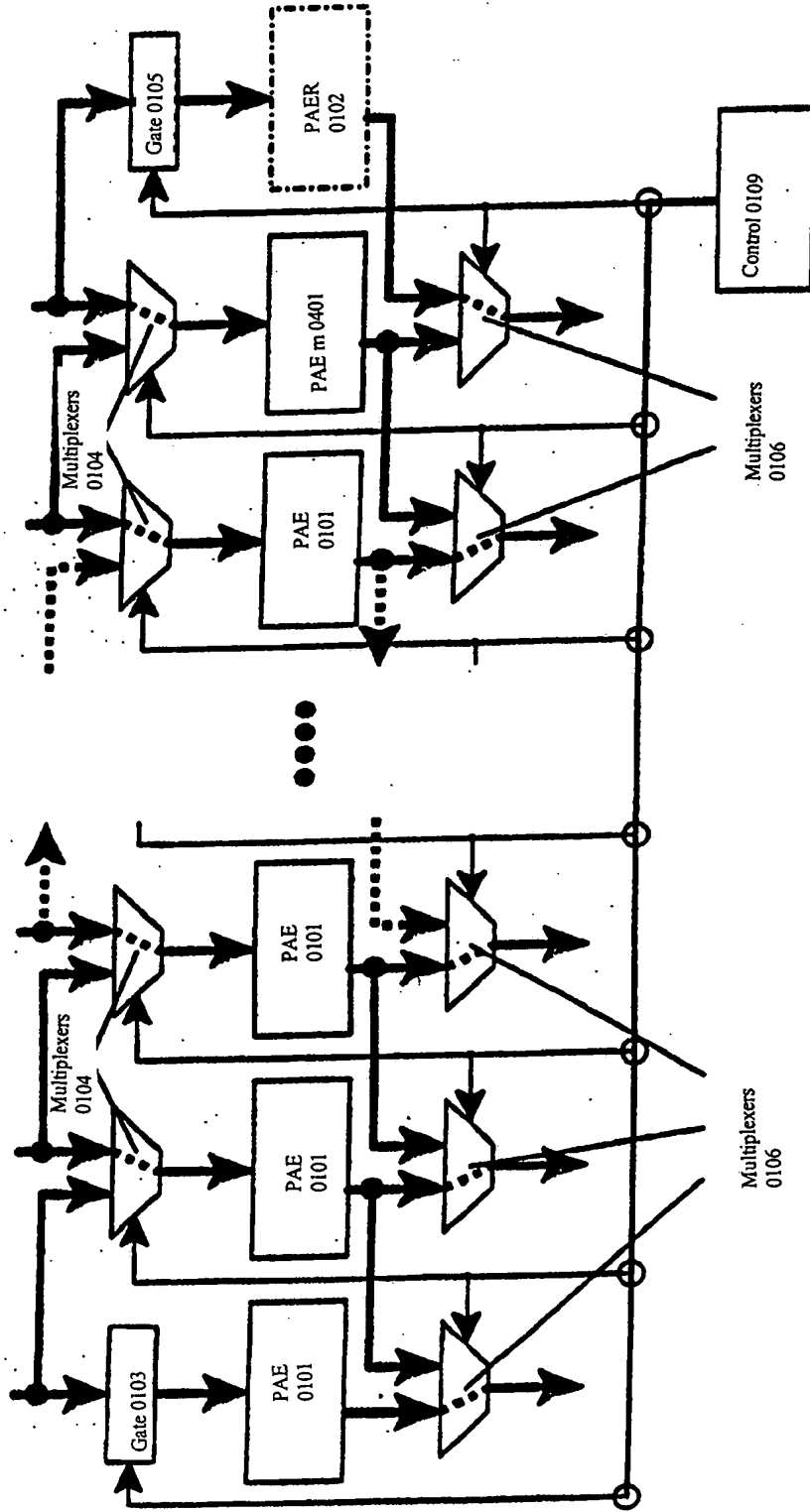

Fig. 4

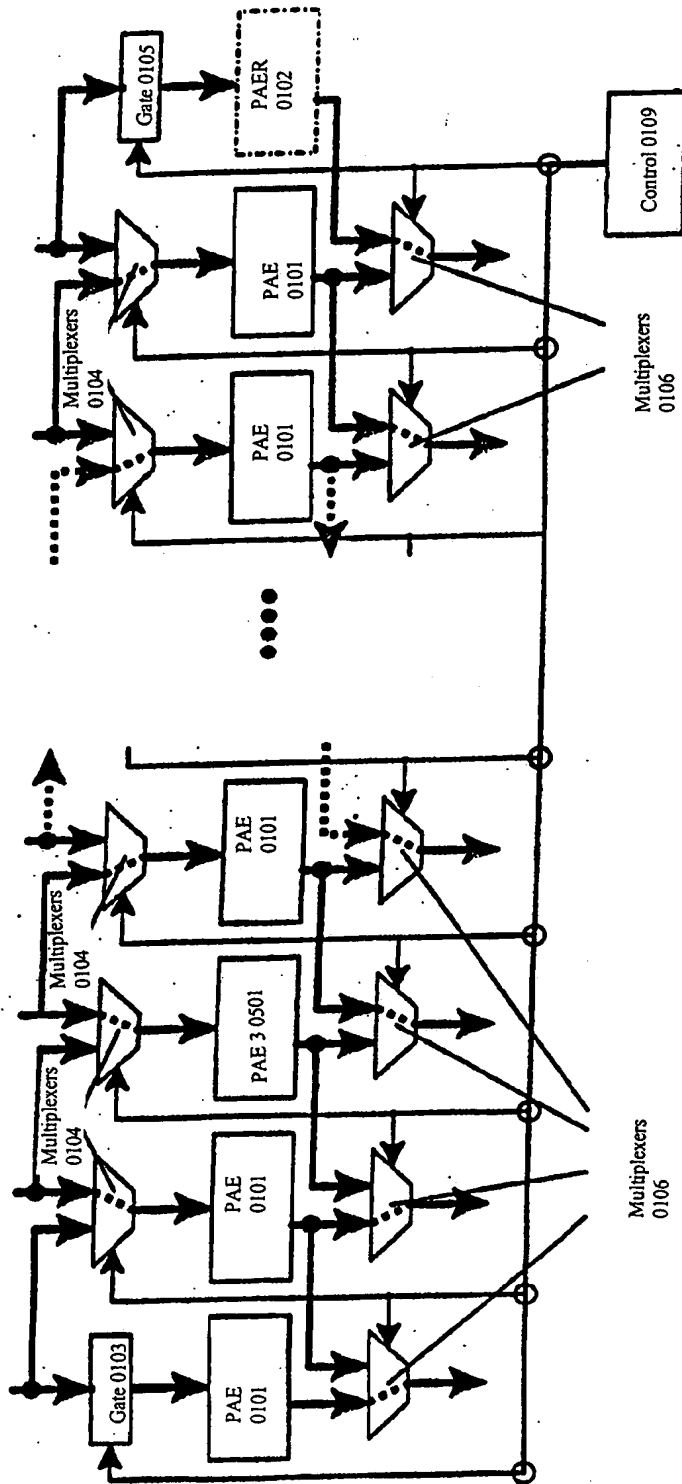

Fig. 5

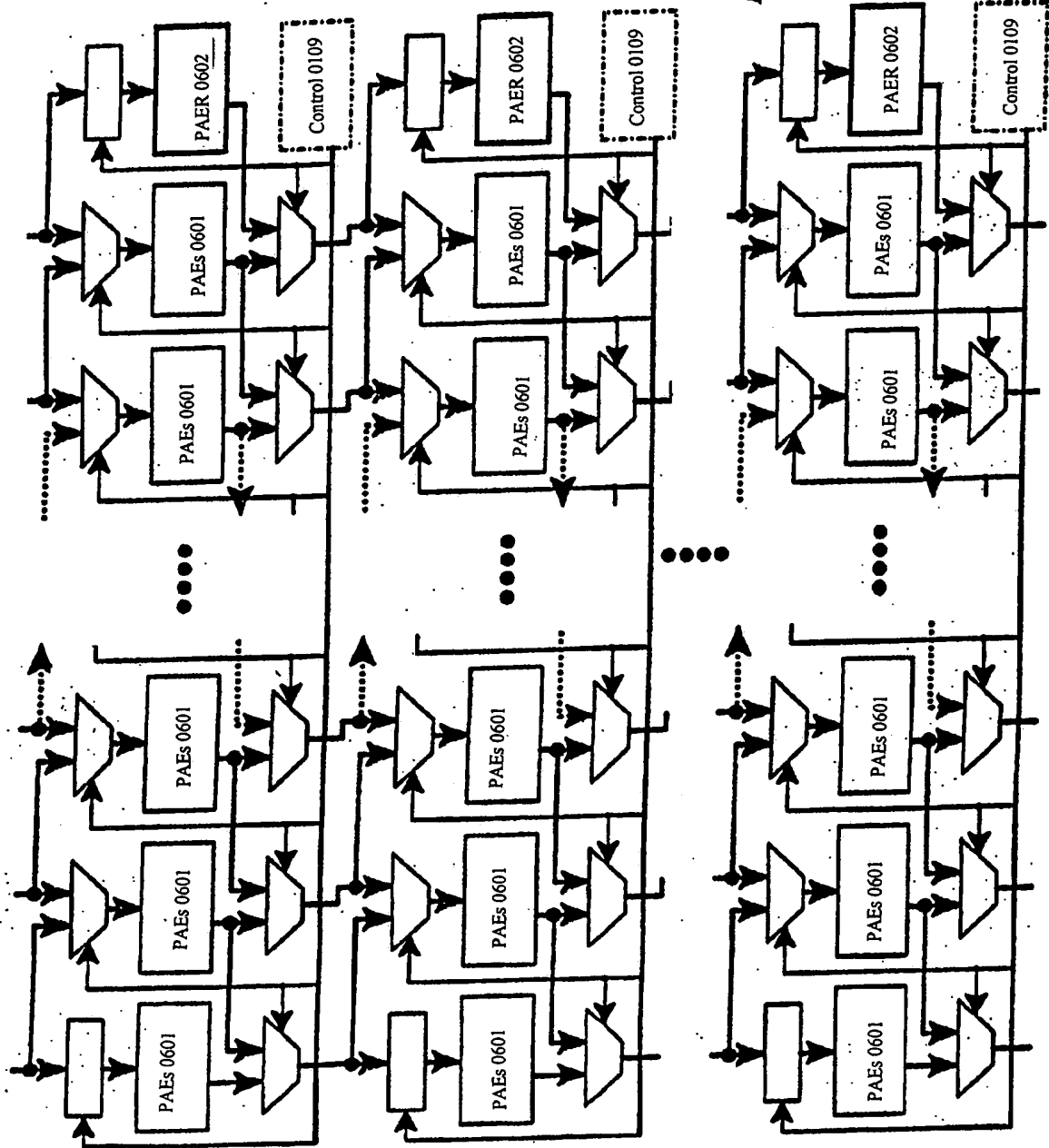

Fig. 6

Fig. 7a

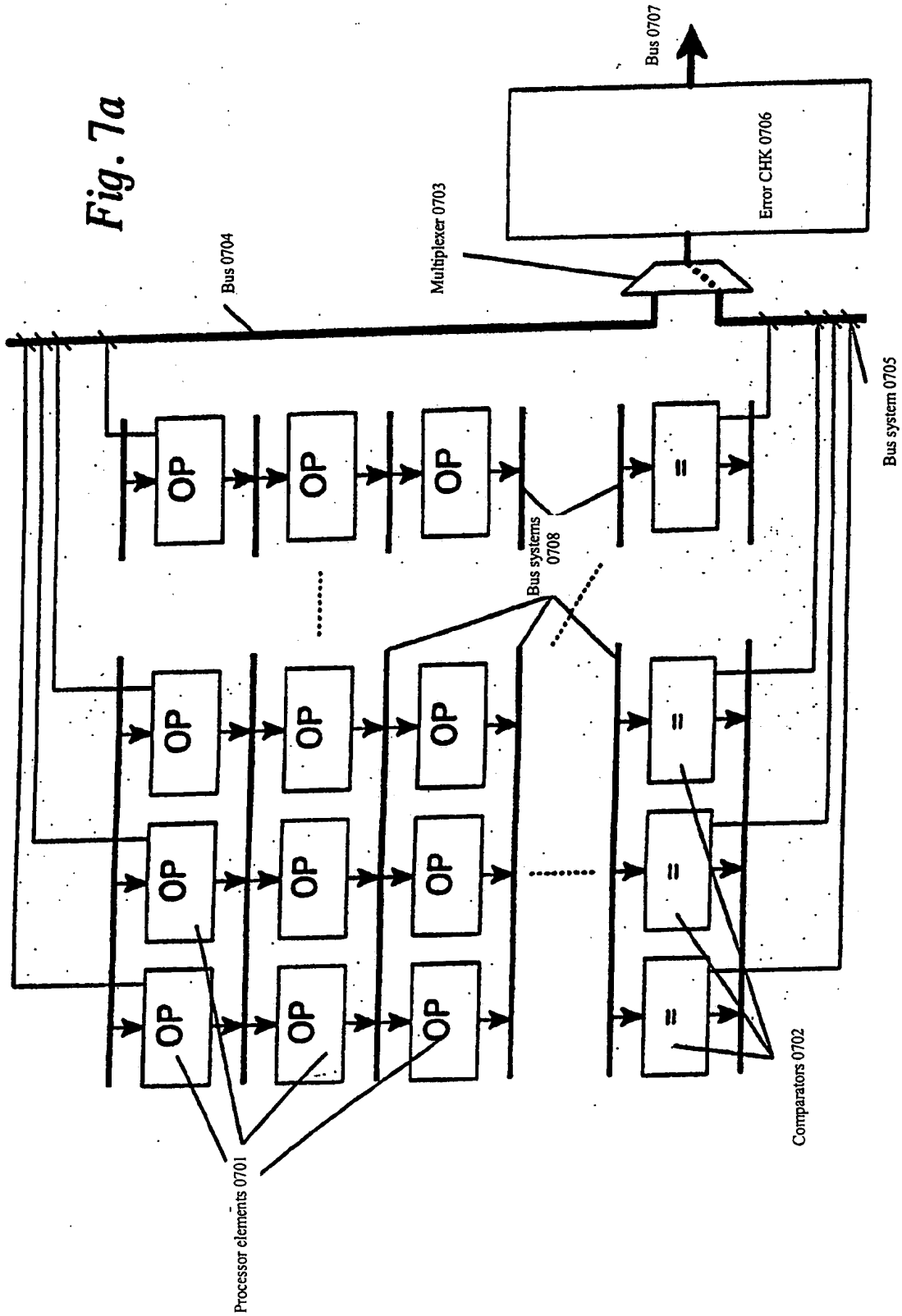
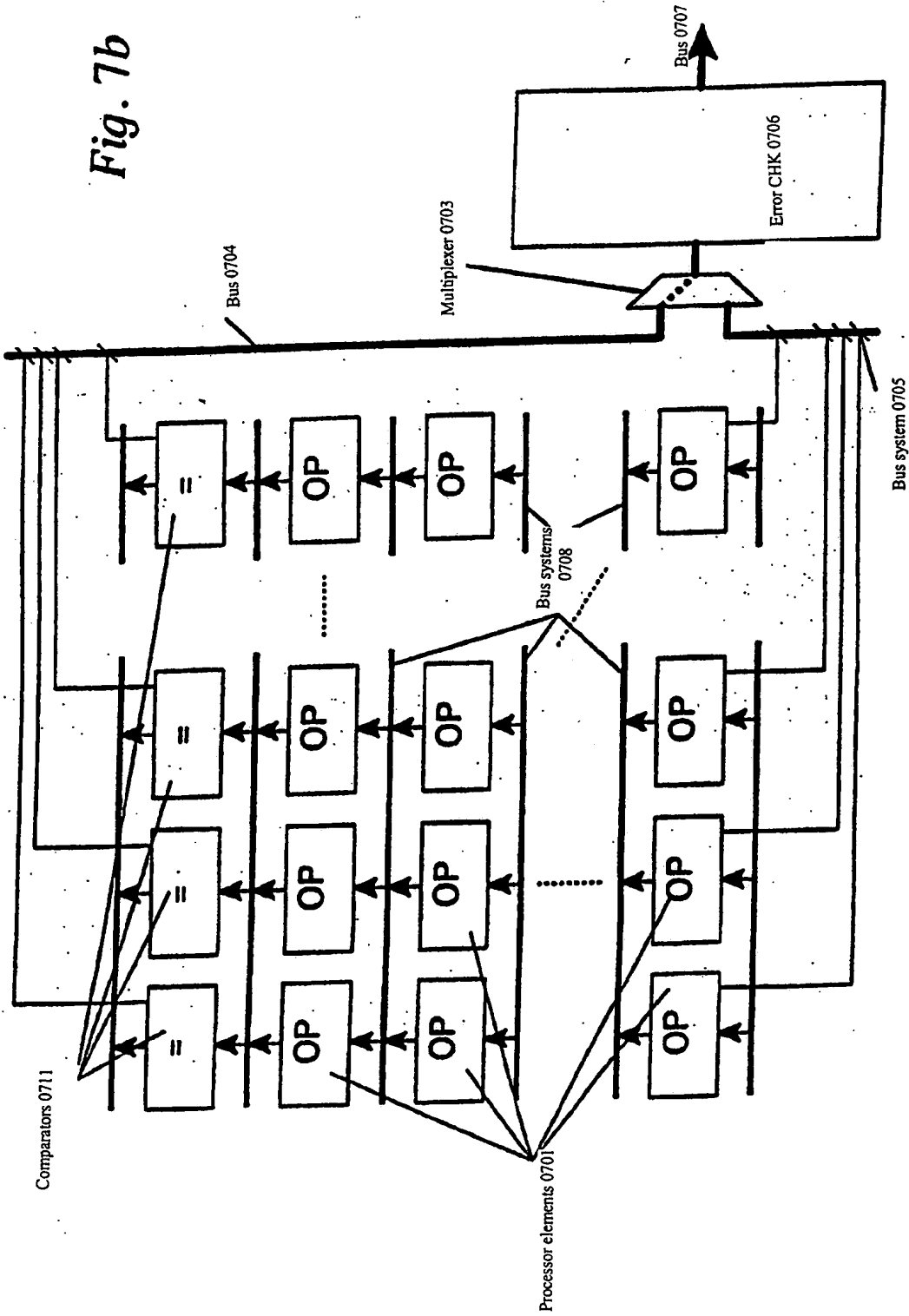
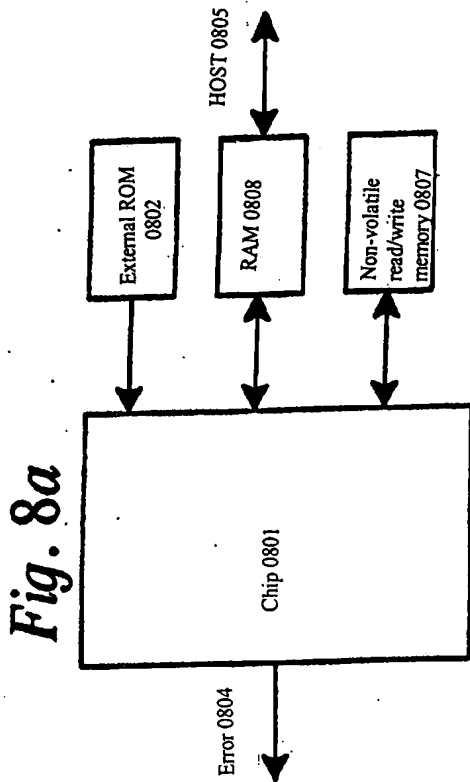
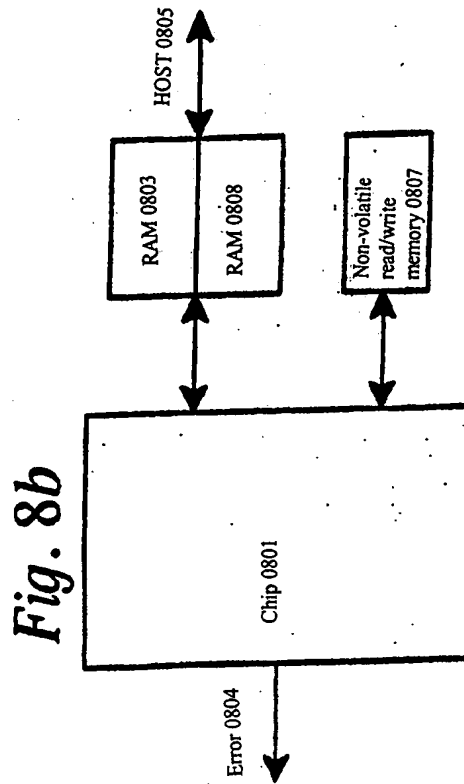
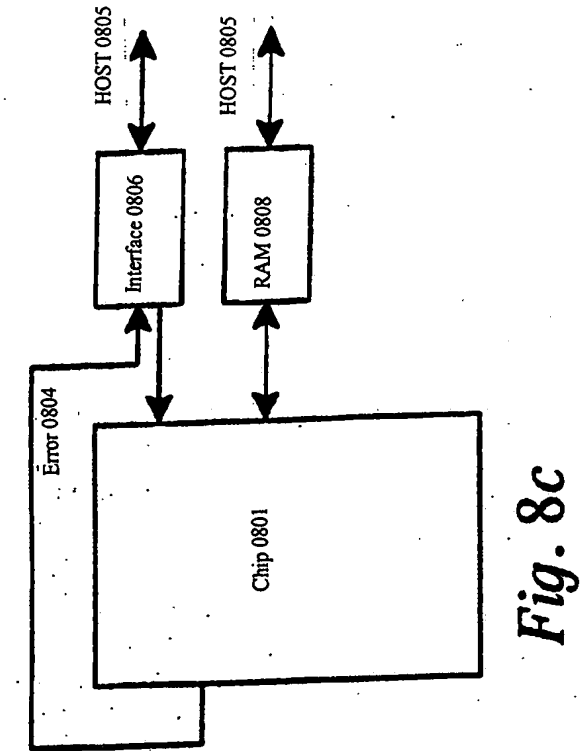

Fig. 7b





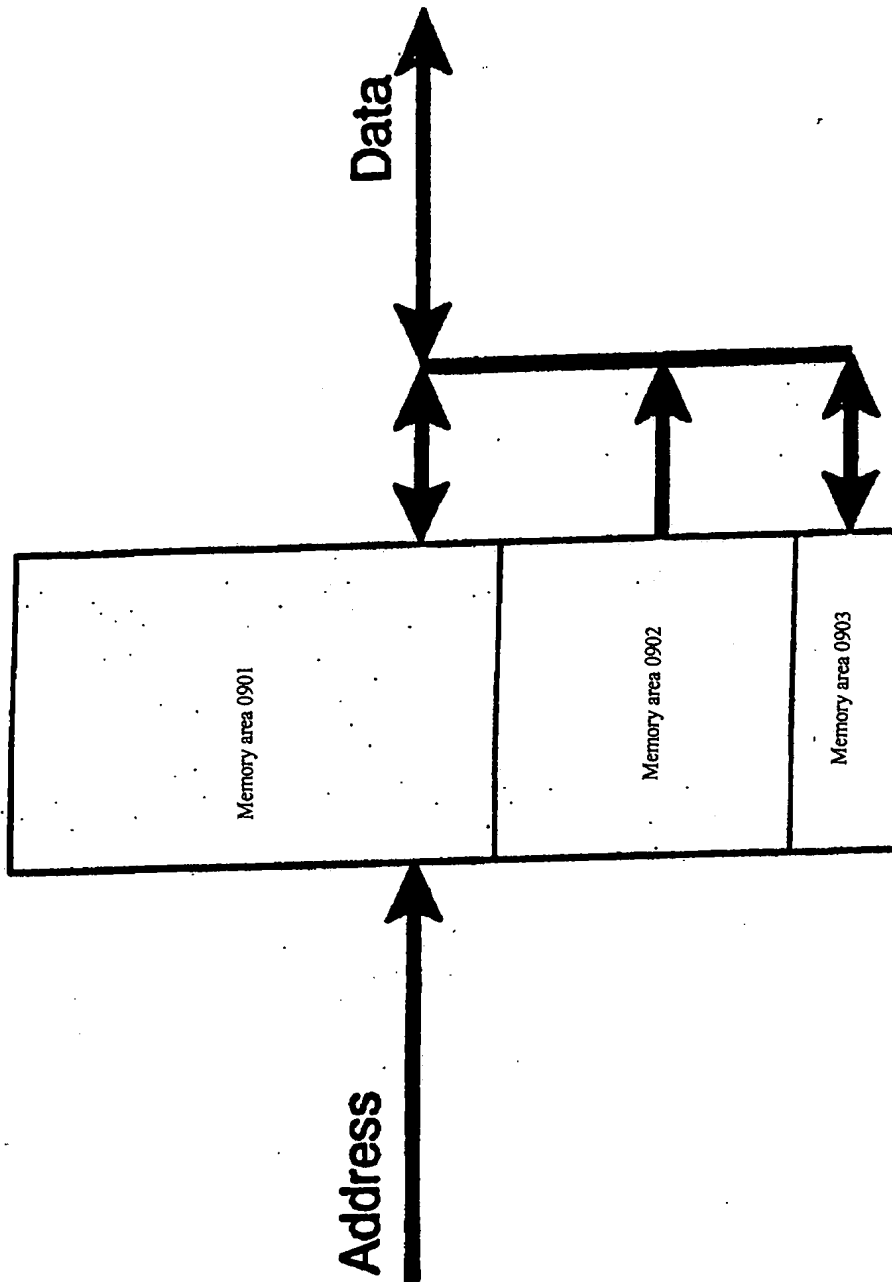

Fig. 9

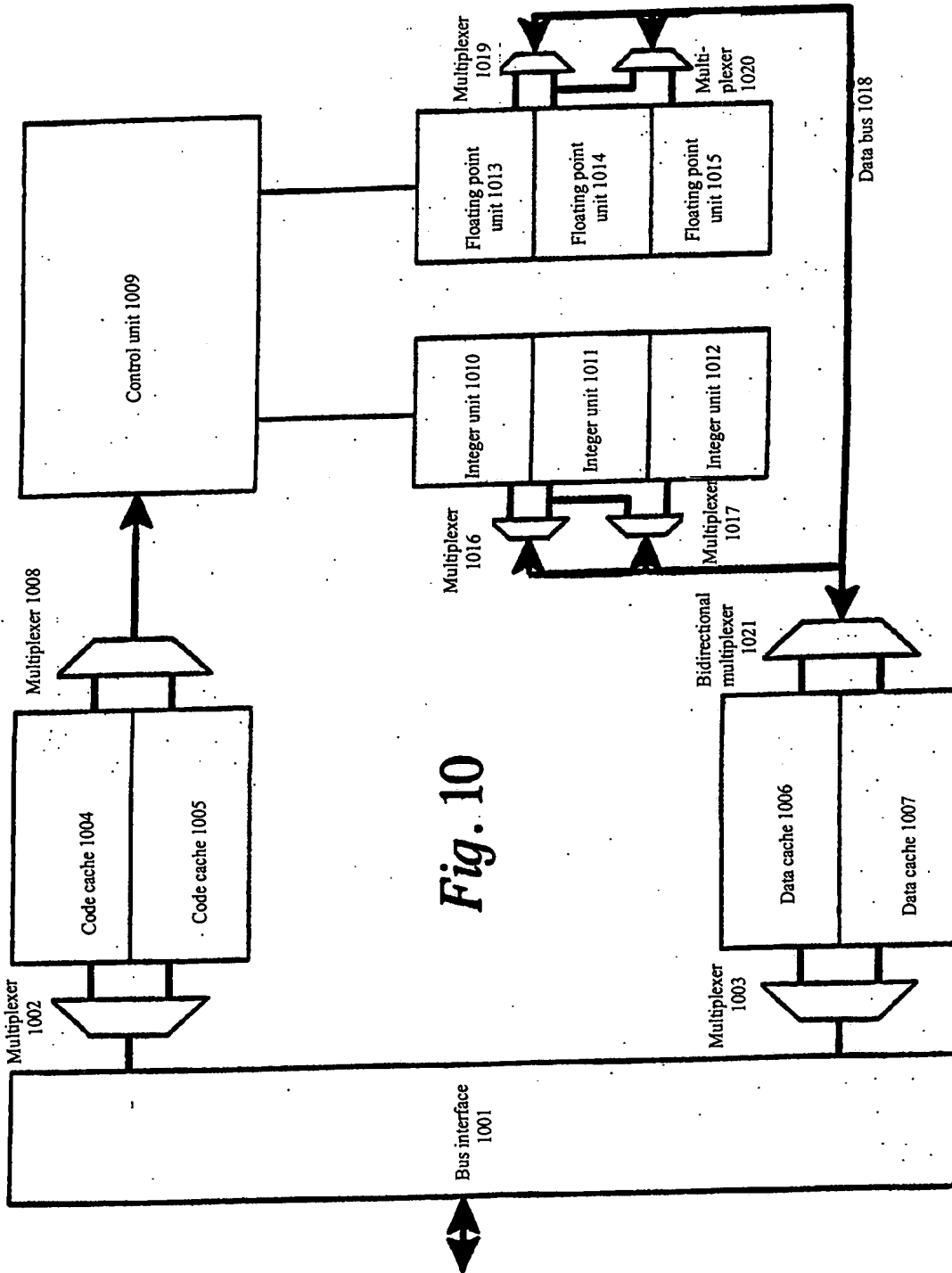

Fig. 10

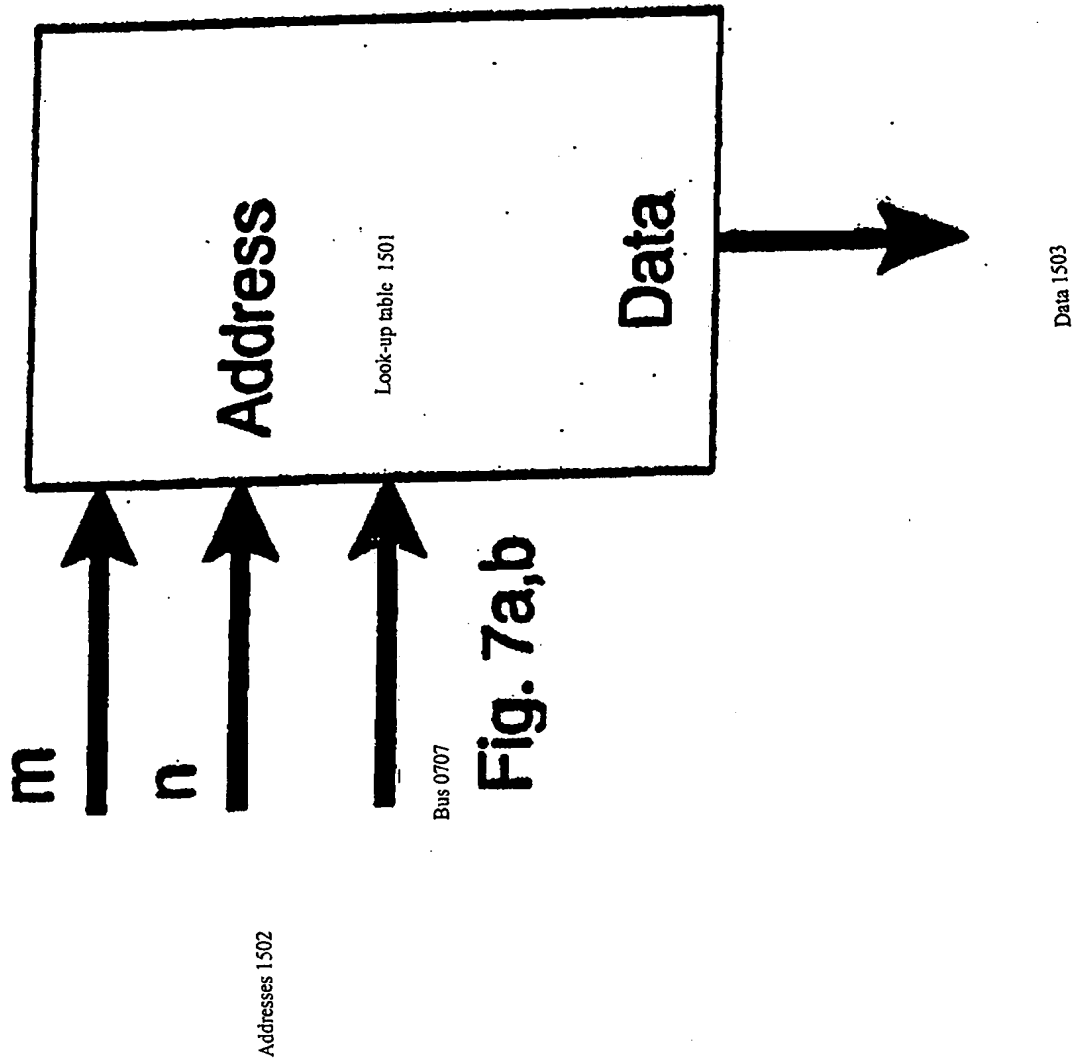
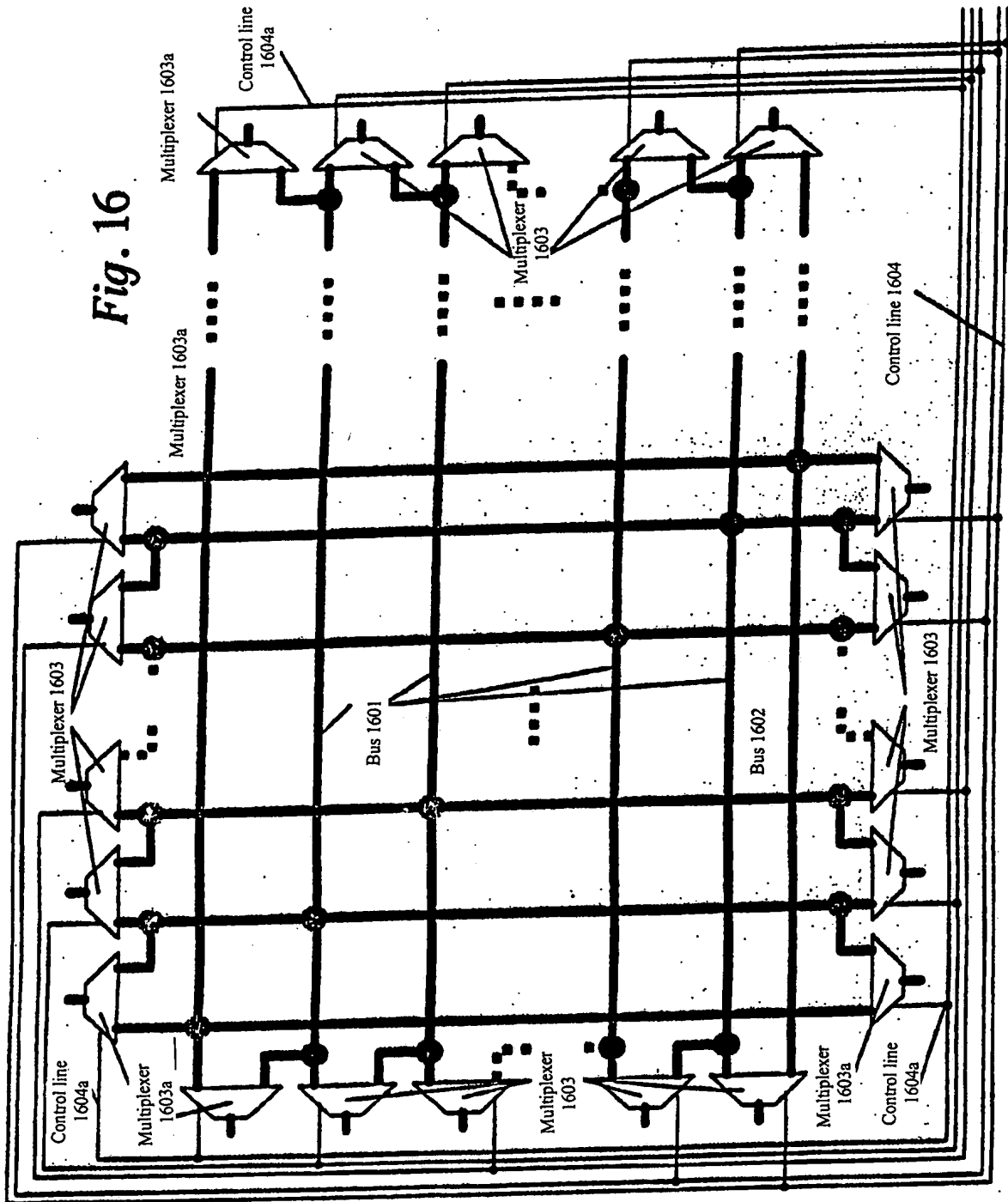

Fig. 15



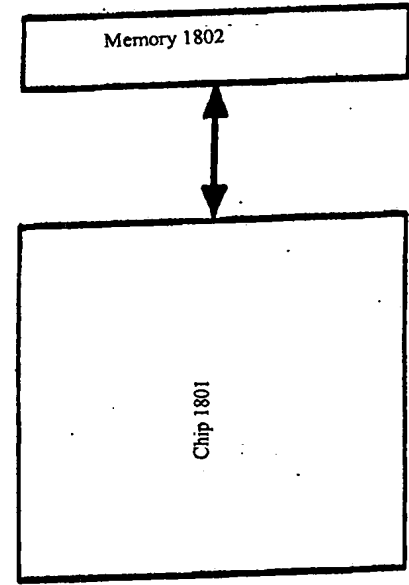

Fig. 18

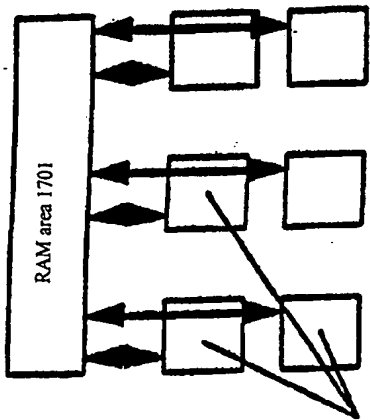

Fig. 17

Cells 1702

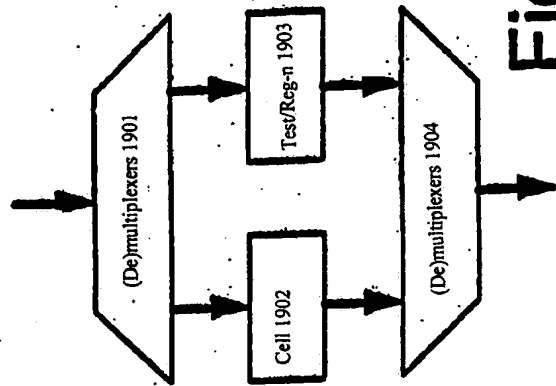

Fig. 19